

Internal Headset

Orbit C-40B

NO.42B/CUP

1-1/8" / 1.5", Retainer bearings

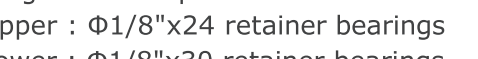
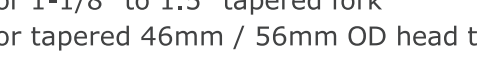
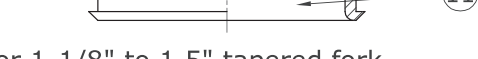
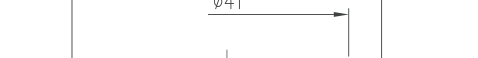
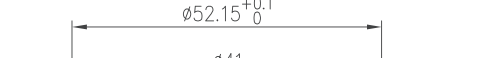
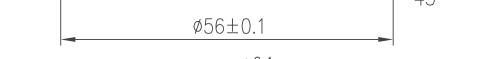
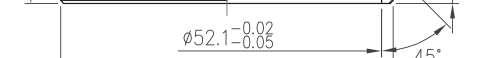
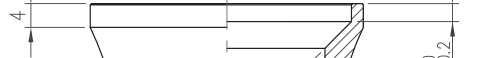
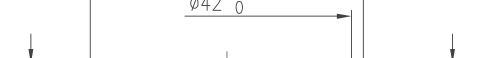
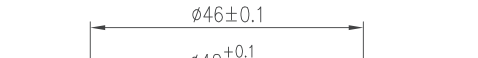
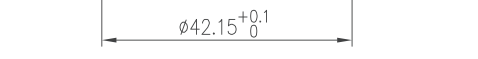
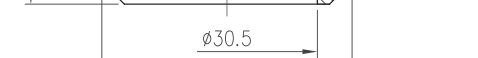
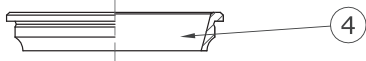
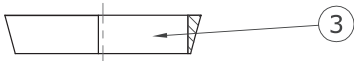
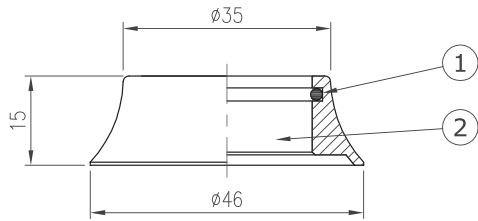

- For 1-1/8" to 1.5" tapered fork
- For tapered 46mm / 56mm OD head tube
- Alloy top cover
- Forged steel cups
- Upper : $\Phi 1/8" \times 24$ retainer bearings
- Lower : $\Phi 1/8" \times 30$ retainer bearings

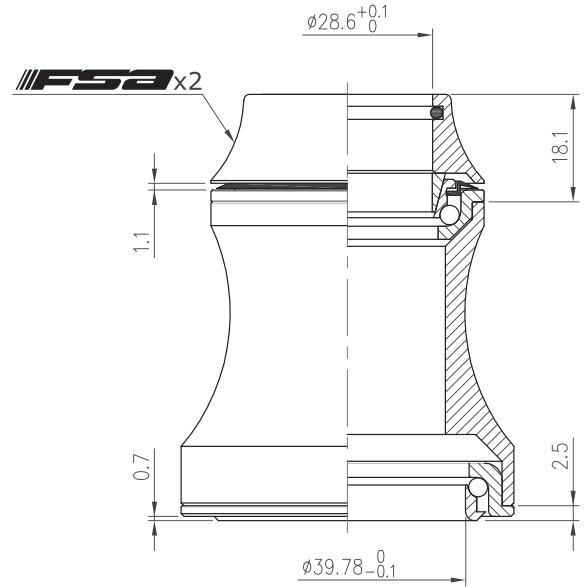

Stack Height $18.1 + 2.5 = 20.6$



Weight - 106 grams

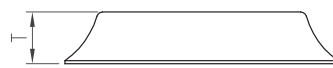

Custom cone spacer		
Item No	T	Stack Height
H2084A	8.7mm	14.3mm

No	Item No	Material	Qty
11	H6125{Orbit E 1.5-6}	Steel	1PCS
10	MR101{ $\Phi 1/8" \times 30$ }	Steel	1PCS
9	H5076{NO.42B/CUP-5}	Steel	1PCS
8	H4139{NO.42B/CUP-4}	Steel	1PCS
7	MR048{ $\Phi 1/8"$ }	Chrome steel	54PCS
6	MR064{ $\Phi 1/8" \times 24$ }	Steel	1PCS
5	MS094{NO.10A}	ABS	1PCS
4	H3037{NO.10AY-3}	Steel	1PCS
3	H2074{NO.10AY-2}	Alloy	1PCS
2	H2084B{NO.10AY-2}	Alloy	1PCS
1	MS053{872}	Rubber	1PCS

